



Level Switch

NRS 2-50

NRS 2-51

EN
English

Original Installation Instructions
819179-03

Contents

Page

Important Notes

Usage for the intended purpose.....	4
Function.....	4
Safety note.....	4

Directives and Standards

VdTÜV Bulletin "Wasserstand 100" (= Water Level 100)	5
LV (Low Voltage) Directive and EMC (Electromagnetic Compatibility).....	5
ATEX (Atmosphère Explosible)	5
UL/cUL (CSA) Approval	5
Note on the Declaration of Conformity / Declaration by the Manufacturer CE	5
Approvals for Marine Applications	5

Technical data

NRS 2-50, NRS 2-51	6
Scope of supply	7

In control cabinet: Mounting level switch

Dimensions NRS 2-50, NRS 2-51	8
Key	8
Installation in control cabinet.....	8
Name plate / marking	9

In control cabinet: Wiring level switch

Wiring diagram for level switch NRS 2-50	10
Key	10
Wiring diagram for level switch NRS 2-51	11
Key	11
Connecting supply voltage	12
Connecting output contacts.....	12
Connecting level electrode, level transmitter	12
Connection for actual-value output	12
Tools	12

In the plant: Wiring level electrode / level transmitter

Connecting level electrode, level transmitter	13
---	----

Contents - continued -

Page

Factory settings	13
-------------------------------	----

Changing factory settings

Changing function and input for level electrode/transmitter	14
---	----

Operating the level switch

Key to codes on seven-segment display	16
Establishing measuring range	17

Commissioning procedure

Setting parameters.....	18
Setting the measuring range	19

Operation, alarm and test

Indicators.....	20
Level controller NRR 2-50 Displays	21
Level controller NRR 2-51 Displays	21

Troubleshooting

Indication, diagnosis and remedy	22
--	----

Further Notes

Action against high frequency interference.....	23
Decommissioning / replacing the equipment.....	23
Disposal.....	23

Important Notes

Usage for the intended purpose

The level switch NRS 2-50 / NRS 2-51 in conjunction with level electrodes NRG 2-.. and level transmitter NRGT 26-1 is used as limit switch and water level controller, for instance in steam boilers, (pressurized) hot-water installations as well as condensate and feedwater tanks. The level switch detects and indicates when the preset MIN and MAX water level is reached and switches the feedwater pump on and off (NRS 2-51).

The level switch NRS 2-50 / NRS 2-51 is designed to be used with level electrodes NRG 21-.. and NRG 26-21 as well as the level transmitter NRGT 26-1.. .

Function

The **level switch NRS 2-50, NRS 2-51** uses the level-dependent voltage signal emitted by the level electrodes NRG 2-.. or the level-dependent current signal emitted by the level transmitter NRGT 26-1.

The **level switch NRS 2-50 / NRS 2-51** adjusts the input signal to 0 and 100 % of the boiler measuring range and the switchpoints for MIN / MAX water level are correspondingly adjusted within this measuring range. During normal operation the actual value is indicated on the seven-segment LED display.

When the MIN or MAX water level is reached, the MIN or MAX output contact is switched over after the de-energizing delay and the MIN or MAX LED is illuminated.

The **level switch NRS 2-51** also works as on-off water level controller (**fill or discharge control, switch-selectable**). If the lower or upper switchpoint for water level control is reached, the controller output switches over according to the preset function and, consequently, switches the feedwater pump on or off. The amber LED is illuminated when the feedwater pump is switched on by the level switch.

Any faults or malfunctions in the level electrode, the level transmitter, the electrical connection or the settings will be indicated by the seven-segment LED display. In the event of a malfunction a MIN and MAX alarm will be triggered.

If errors occur only in the **level switch NRS 2-50 / NRS 2-51**, a MIN and MAX alarm is raised and the system is restarted.

Parameter settings can be changed or a MIN/MAX alarm be simulated by operating the rotary button.

For external level indication the equipment is available with an actual-value output 4 - 20 mA.

Safety note

The equipment must only be installed, wired and commissioned by qualified and competent staff. Retrofitting and maintenance work must only be performed by qualified staff who - through adequate training - have achieved a recognised level of competence.



Danger

The terminal strips of the equipment are live during operation. This presents the danger of electric shock!

Always cut off power supply to the equipment before mounting, removing or connecting the terminal strips!



Attention

The name plate specifies the technical features of the equipment. Note that any piece of equipment without its specific name plate must neither be commissioned nor operated.

Directives and Standards

VdTÜV Bulletin “Wasserstand 100” (= Water Level 100)

The level switch NRS 2-50 / NRS 2-51 in conjunction with level electrode NRG 2-... and level transmitter NRG 26-1.. is type approved to VdTÜV Bulletin “Water Level 100”.

The VdTÜV Bulletin “Wasserstand (= Water Level) 100” specifies the requirements made on water level control and limiting equipment for boilers.

LV (Low Voltage) Directive and EMC (Electromagnetic Compatibility)

The equipment meets the requirements of the Low Voltage Directive 2014/35/EU and the EMC Directive 2014/30/EU.

ATEX (Atmosphère Explosible)

According to the European Directive 2014/34/EU the equipment must **not** be used in explosion risk areas.

UL/cUL (CSA) Approval

The equipment meets the requirements of Directives: UL 508 and CSA C22.2 No. 14-13, Standards for Industrial Control Equipment. File E243189.

Note on the Declaration of Conformity / Declaration by the Manufacturer C€

For details on the conformity of our equipment according to the European Directives see our Declaration of Conformity or our Declaration of Manufacturer.

The current Declaration of Conformity / Declaration of Manufacturer are available in the Internet under www.gestra.com/documents or can be requested from us.

Approvals for Marine Applications

The level switch NRS 2-5.. in conjunction with level transmitter NRG 26-1S is approved for marine applications.

Technical data

NRS 2-50, NRS 2-51

Supply voltage

24 VDC +/- 20 %

Fuse

external 0.5 A (semi-delay)

Power consumption

4 VA

Connection of level electrode / level transmitter (switch-selectable)

1 input for level electrode NRG 21-.. and NRG 26-21, with 3 poles and screen, or

1 analog input 4-20 mA, e. g. for level transmitter NRGT 26-1, with 2 poles and screen

Supply voltage of level electrode

12 VDC

Outputs

NRS 2-50, NRS 2-51: 2 volt-free change-over contacts, 8 A 250 V AC / 30 V DC $\cos \varphi = 1$.

De-energizing delay: 3 sec. (MIN / MAX alarm, switchpoint adjustable).

NRS 2-51: 1 volt-free change-over contact, 8 A 250 V AC / 30 V DC $\cos \varphi = 1$.

(e. g. feedwater pump ON, switchpoint adjustable).

Provide inductive loads with RC combinations according to manufacturer's specification to ensure interference suppression.

NRS 2-50, NRS 2-51: 1 analogue output 4-20 mA, max. load 500 ohm, e. g. for actual-value indication.

Indicators and adjustors

1 rotary button with integrated pushbutton "Test" for simulating MIN / MAX alarm and setting the parameter,

1 seven-segment LED display, four digits, green

2 LEDs red for MIN / MAX alarm,

1 LED amber, e. g. for feedwater pump ON (NRS 2-51),

1 code switch, 4 poles, for configuration

Housing

Housing material: base: polycarbonate, black; front: polycarbonate, grey

Conductor size: 1 x 4,0 mm² solid per wire or

1 x 2.5 mm² per stranded wire with sleeve to DIN 46228 or

2 x 1.5 mm² per stranded wire with sleeve to DIN 46228 (min. \varnothing 0.1 mm)

Terminal strips can be detached

Fixing of housing:

Mounting clip on supporting rail TH 35, EN 60715

Electrical safety

Pollution degree 2 for installation in control cabinet with protection IP 54, completely insulated

Protection

Housing: IP 40 to EN 60529

Terminal strip: IP 20 to EN 60529

Weight

approx. 0.2 kg

Technical data - continued -

NRS 2-50, NRS 2-51 - continued -

Ambient temperature

when system is switched on: 0 ° 55 °C,
during operation: -10 ... 55 °C

Transport temperature

-20 ... +80 °C (<100 hours), defrosting time of the de-energized equipment before it can be put into operation: 24 hours.

Storage temperature

-20 ... +70 °C, defrosting time of the de-energized equipment before it can be put into operation: 24 hours.

Relative humidity

max. 95 %, no moisture condensation

Approvals:

TÜV certificate

VdTÜV Bulletin "Water Level 100" (= Water Level 100):
Requirements made on water level limiting & control equipment.
Type approval no. TÜV · WR · XX-426 (see name plate)

UL/cUL (CSA) Approval

UL 508 and CSA C22.2 No. 14-13, Standards for Industrial Control
Equipment. File E243189.

Scope of supply

NRS 2-50

1 Level switch NRS 2-50
1 Installation manual

NRS 2-51

1 Level switch NRS 2-51
1 Installation manual

In control cabinet: Mounting level switch

Dimensions NRS 2-50, NRS 2-51

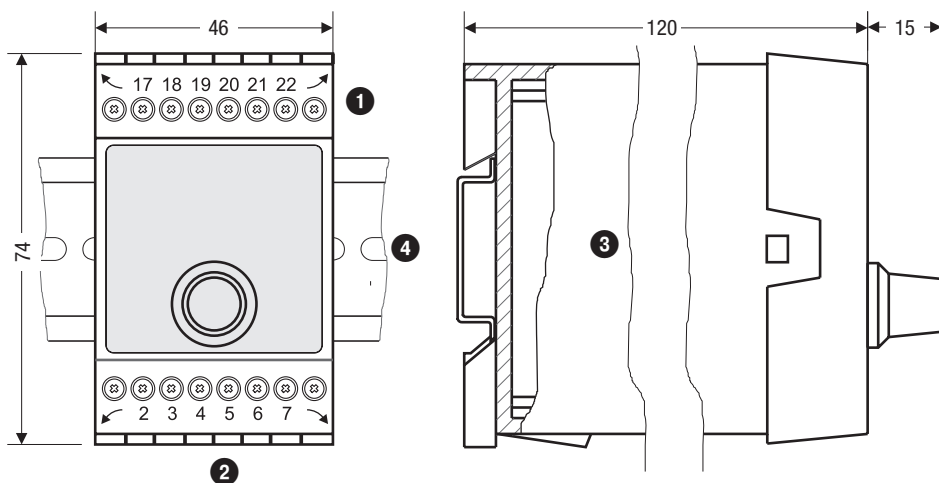

Fig. 1

Key

- | | |
|------------------------|--|
| ① Upper terminal strip | ③ Housing |
| ② Lower terminal strip | ④ Supporting rail type TH 35, EN 60715 |

Installation in control cabinet







The level switch NRS 2-50, NRS 2-51 is clipped onto the support rail type TH 35, EN 60715 in the control cabinet. **Fig. 1** ④







Name plate / marking

Name plate NRS 2-50 (top)

Name plate NRS 2-51 (top)

Type designation

NRS 2-50		Betriebsanleitung beachten See installation instructions Voir instructions de montage		 		GESTRA AG Münchener Str.7.7 D-28215 Bremen	
Niveauschalter Level switch Commutateur de niveau		IP 40 (IP20)				Tamb = 55°C (131°F)	
						250 V ~ T 2,5 A	
16	17	18	19	20	21	22	23

NRS 2-51		Betriebsanleitung beachten See installation instructions Voir instructions de montage		 		GESTRA AG Münchener Str.7.7 D-28215 Bremen	
Niveauschalter Level switch Commutateur de niveau		IP 40 (IP20)				Tamb = 55°C (131°F)	
						250 V ~ T 2,5 A	
16	17	18	19	20	21	22	23

Safety note

Manufacturer

Protection

External fuse for output contacts

Ambient temperature

Output contacts

Name plate (at the bottom)



	1	2	3	4	5	6	7	8
Fuse, provided on site	 M 0,5A							
Power consumption	4VA		OUT 4-20mA 500 Ω				Actual-value output	
Supply voltage	24V = +/- 20%				IN 4-20mA +12V		Connecting level electrode, level transmitter	
	TÜV · WR · XX-426						Approvals	
	Mat-Nr.:						 Disposal note	
Serial number								

Fig. 2

In control cabinet: Wiring level switch

Wiring diagram for level switch NRS 2-50

NRS 2-50

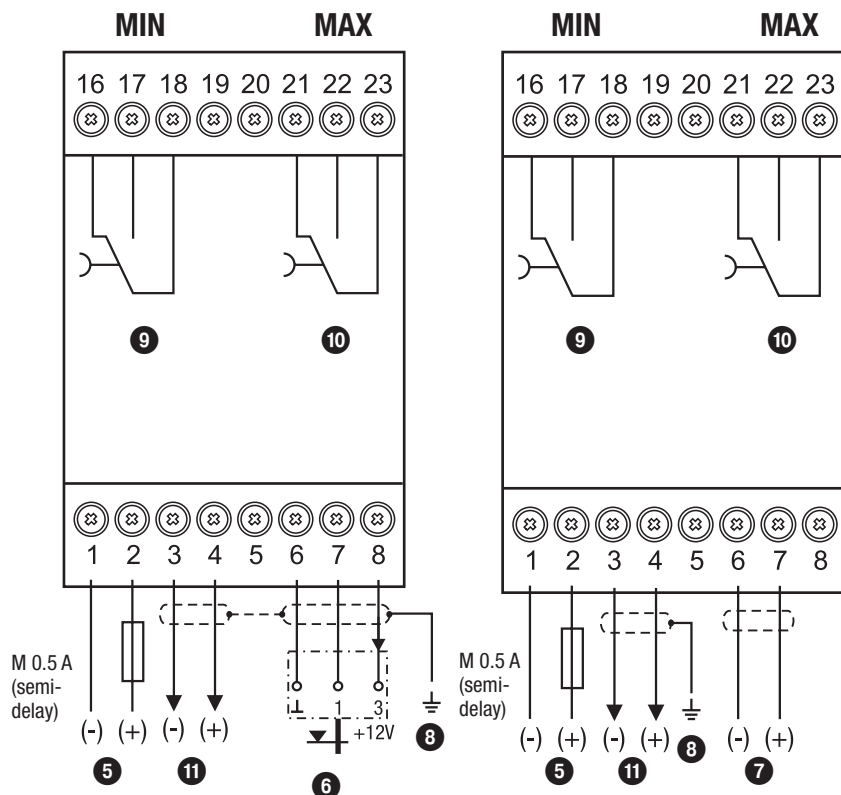

Fig. 3

Key

- 5 Connection of supply voltage **24 V DC** with fuse 0.5 A (semi-delay) provided on site
- 6 Level electrode NRG 21-..; NRG 26-21.
Up to three NRS/NRR 2-5.. can be connected (parallel connection).
- 7 Level transmitter NRG 26-1.., 4-20 mA, screen connected in terminal box.
Up to three NRS/NRR 2-5.. can be connected (series connection).
- 8 Central earthing point (CEP) in control cabinet
- 9 MIN output contact, de-energizing delay: 3 sec.
- 10 MAX output contact, de-energizing delay: 3 sec.
- 11 Actual value output 4-20 mA

Wiring diagram for level switch NRS 2-51

NRS 2-51

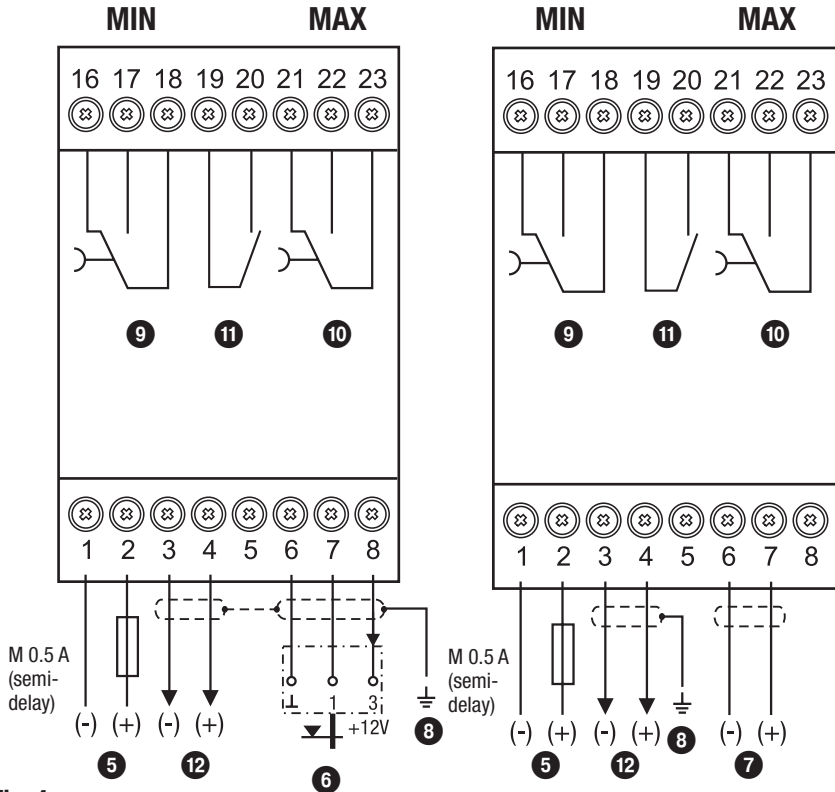

Fig. 4

Key

- 5** Connection of supply voltage **24 V DC** with fuse 0.5 A (semi-delay) provided on site
- 6** Level electrode NRG 21-...; NRG 26-21.
Up to three NRS/NRR 2-5.. can be connected (parallel connection).
- 7** Level transmitter NRG 26-1..., 4-20 mA, screen connected in terminal box.
Up to three NRS/NRR 2-5.. can be connected (series connection).
- 8** Central earthing point (CEP) in control cabinet
- 9** MIN output contact, de-energizing delay: 3 sec.
- 10** MAX output contact, de-energizing delay: 3 sec.
- 11** Pump output contact
- 12** Actual value output 4-20 mA

In control cabinet: Wiring level switch - continued -

Connecting supply voltage

The equipment is supplied with 24 V DC and fused with an external semi-delay fuse 0.5 A. Please use a safety power supply unit with safe electrical isolation.

The power supply unit must be electrically isolated from dangerous contact voltages and must meet at least the requirements on double or reinforced isolation according to one of the following standards: DIN EN 50178, DIN EN 61010-1, DIN EN 60730-1 or DIN EN 60950.

Connecting output contacts

Wire the upper terminal strip ① (terminals 16-23) according to the desired switching functions.

Provide an external slow-blow fuse 2.5 A for the output contacts.

When switching off inductive loads, voltage spikes are produced that may impair the operation of control and measuring systems. Connected inductive loads must be provided with suppressors such as RC combinations as specified by the manufacturer.

Connecting level electrode, level transmitter

To connect the equipment use screened multi-core control cable with a min. conductor size 0.5 mm², e. g. LiYCY 4 x 0.5 mm², max. length: 100 m. Up to three level switches/controllers NRS/NRR 2-5.. can be connected to one level electrode or one level transmitter.

Wire terminal strip in accordance with the wiring diagram. **Fig. 3, 4**

Wire screen in accordance with the wiring diagram.

Make sure that connecting cables leading to the equipment are segregated and run separately from power cables.

Connection for actual-value output

To connect the equipment use screened multi-core control cable with a min. conductor size 0.5 mm², e. g. LiYCY 2 x 0.5 mm², max. length: 100 m.

Please observe the max. load of 500 ohm.

Wire terminal strip in accordance with the wiring diagram. **Fig. 3, 4**

Connect the screen **only once** to the central earthing point (CEP) in the control cabinet.

Make sure that connecting cables leading to the equipment are segregated and run separately from power cables.

Any item of equipment that you want to connect to the terminals for the actual-value output 4 - 20 mA must be certified to have at least double or reinforced isolation according to DIN EN 50178 or DIN EN 61010-1 or DIN EN 60730-1 or DIN EN 60950 (safe electrical isolation) between the current loop and live parts of the equipment that are not supplied with safety extra-low voltage (SELV).



Attention

- Do not use unused terminals as support point terminals.

Tools

- Screwdriver size 3.5 x 100 mm, completely insulated according to VDE 0680-1.

In the plant: Wiring level electrode / level transmitter

Connecting level electrode, level transmitter

The level switch NRS 2-50 / NRS 2-51 is designed to be used with level electrodes NRG 21-.. and NRG 26-21 as well as the level transmitter NRGT 26-1...

To connect the equipment use screened multi-core control cable with a min. conductor size 0.5 mm², e. g. LiYCY 4 x 0.5 mm², max. length: 100 m.

Wire screen in accordance with the wiring diagram.



Attention

- Follow the instructions given in the installation & operating manual for NRG 21-.., NRG 26-21 and NRGT 26-1.. when putting the level electrode or the level transmitter into operation.
- Make sure that connecting cables leading to the equipment are segregated and run separately from power cables.
- The level transmitter must be separately connected to its own voltage supply.

Factory settings

Level switch NRS 2-50

- De-energizing delay: 3 sec., factory set
- Voltage input for connecting a level electrode type NRG 21-.. or type NRG 26-21.
- MAX switchpoint AL.Hi = 80 %
- MIN switchpoint AL.Lo = 20 %
- Calibration value CAL.P = 100 %

Code switch ⑬: S1,S2,S3, S4 OFF

Level switch NRS 2-51

- De-energizing delay: 3 sec., factory set
- Voltage input for connecting a level electrode type NRG 21-.. or type NRG 26-21.
- MAX switchpoint AL.Hi = 80 %
- MIN switchpoint AL.Lo = 20 %
- Switchpoint SP.Lo = 40 %, pump ON (fill), pump OFF (discharge)
- Switchpoint SP.Hi = 60 %, pump OFF (fill), pump ON (discharge)
- Calibration value CAL.P = 100 %
- Function "Fill control"

Code switch ⑪: S1,S2,S3, S4 OFF

Changing factory settings



Danger

The upper terminal strip of the equipment is live during operation.

This presents the danger of electric shock!

Always **cut off power supply** to the equipment before mounting, removing or connecting the terminal strips!

Changing function and input for level electrode/transmitter

The input and the function are determined by the code switch 20 setting.

To change the code switch setting proceed as follows:

- Cut off supply voltage.
- Remove **lower** terminal strip. **Fig. 4**
 - Insert a screwdriver to the right and left of the arrow markings between the terminal strip and the front frame.
 - Unlock terminal strip on the left and right side. For this purpose move screwdriver in direction of the arrow.
 - Remove the terminal strip.

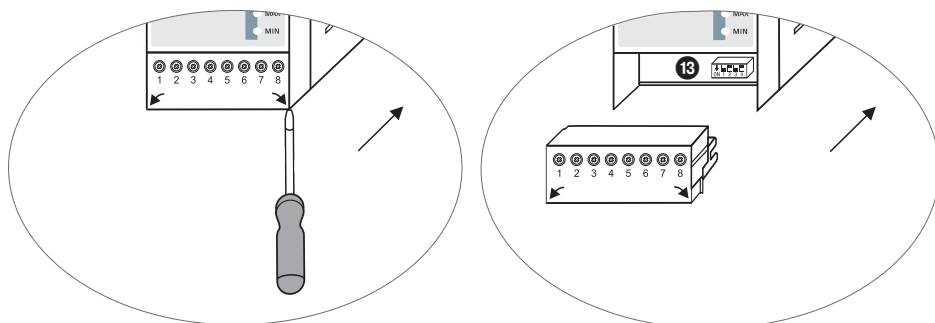

Fig. 4

After the new code switch settings have been established as new defaults:

- Re-attach lower terminal strip.
- Apply supply voltage. Equipment is restarted.

Changing factory settings - continued -

Changing function and input for level electrode/transmitter - continued -

If you want to change the input or the function, set the switches S2 to S3 of the code switch 13 as indicated in the following table **Fig. 5**.

Code switch 13		 Toggle switch, white	
Level switch NRS 2-50		S 3	
Input for connecting level electrode NRG 21-.. or NRG 26-21			OFF
Input for connecting level transmitter NRGT 26-1.. *			ON
Level switch NRS 2-51		S 2	S 3
Input for connecting level electrode NRG 21-.. or NRG 26-21		OFF	
Input for connecting level transmitter NRGT 26-1.. *		ON	
Fill control		OFF	
Discharge control		ON	

Fig. 5

grey = factory setting



Attention

* When connecting level transmitter NRGT 26-1.. set the upper and the lower end of the measuring range **only** in the transmitter. For this purpose follow the instructions given in the installation & operating manual for the NRGT 26-1..!

Do **not** change the code switch 13 settings of S1 and S4!

Operating the level switch

Key to codes on seven-segment display

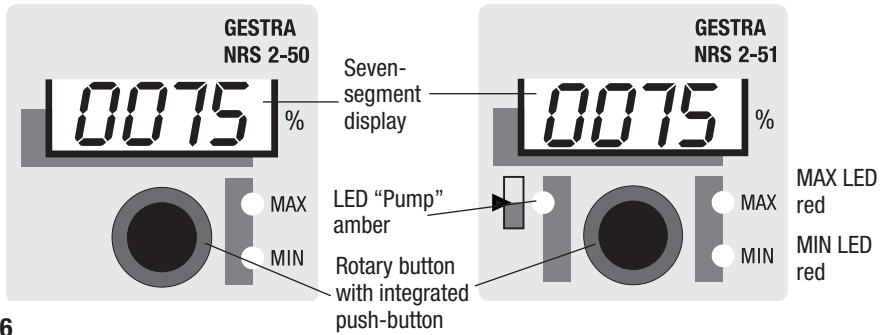

Fig. 6

Code	Description		
Indicated when rotary button is turned to the right:			
AL.Hi	Alarm High	MAX switchpoint	adjustable between 0 and 100 % C
AL.Lo	Alarm Low	MIN switchpoint	
SP.Hi	Setpoint High	only NRS 2-51: switchpoint "Pump OFF" (fill), "Pump ON" (discharge), adjustable between 0 and 100 % C	
SP.Lo	Setpoint Low	only NRS 2-51: switchpoint "Pump ON" (fill), "Pump OFF" (discharge), adjustable between 0 and 100 % C	
tESt	Test	Tests output relays	
CAL.L	Calibrate L	NRG 21-.. or NRG 26-21 is connected	establish lower end of measuring range
CAL.P	Calibrate %		adjustable between \geq 25 and \leq 100 %
CAL.H	Calibrate H		establish upper end of measuring range
Indicated when in parameterization mode:			
quit	Quit	Input not confirmed	
done	Done	Input confirmed	
Indicated if malfunctions occur:			
E.005	Error	Level electrode/transmitter defective, measuring voltage/current too low	
E.006	Error	Level electrode/transmitter defective, measuring voltage/current too high	
E.012	Error	Beginning and end of measuring range have been switched round.	
E.013	Error	MIN switchpoint above MAX switchpoint	

Operating level switch - continued -

Establishing measuring range

- A** Lower end of measuring range, adjustable
- B** Upper end of measuring range, adjustable
- C** Measuring range [mm] = xxx %
- D** Inactive range
- E** Max. length of installation 238 °C

Adjust the lower and upper end of the measuring range for level control. The resulting measuring range **C** is the active control range. Please calculate the percentage value of the measuring range.

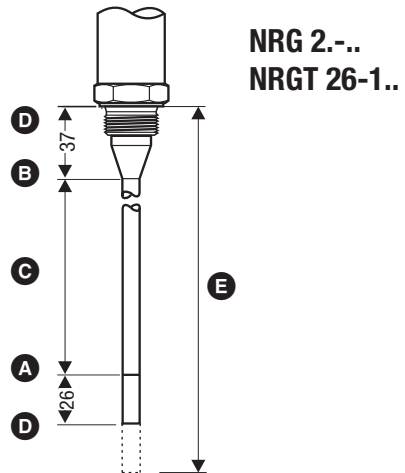

Attention

* When connecting level transmitter NRGT 26-1.. set the upper and the lower end of the measuring range **only** in the transmitter.

Commissioning procedure

Setting parameters

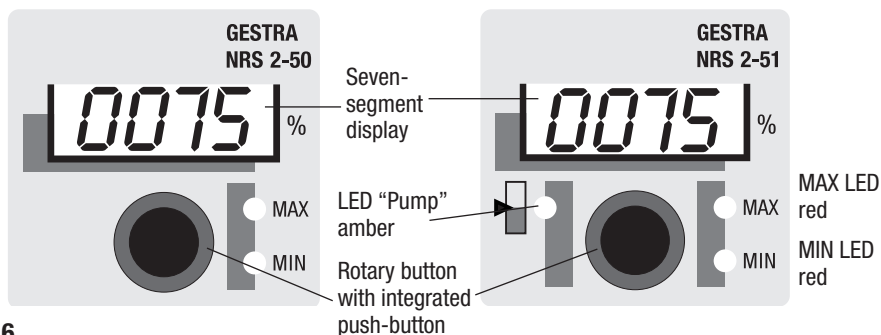

Fig. 6

Start		
Activity	Display	Function
Switch on supply voltage. Water level between MIN and MAX.	Seven-segment display shows equipment and software version.	System test, takes approx. 3 sec.
	Seven-segment display shows actual value	System switches to operating mode.

Setting parameters		
Activity	Seven-segment display	Function
Turn rotary button until the desired parameter is indicated.	Display toggles between parameter and the saved value setting.	For selecting the parameter
Press and hold down the push-button (of the rotary button)	First digit (0000) flashing.	Parameterization mode active. You can change the first digit.
Turn rotary button.	A new value is indicated.	To increase the value turn rotary button to the right, to decrease turn it to the left.
Press push-button briefly.	2nd, 3rd or 4th digit is flashing. (from right to left)	2nd, 3rd or 4th digit can be changed by turning the rotary button. To increase the value turn rotary button to the right, to decrease turn it to the left.
After input press push-button within 3 sec. and hold down	“done” is indicated for a moment. Then the display toggles between parameter and the new value setting.	Input is confirmed. System switches back to parameter.
<i>If input is not confirmed within 3 sec. or if no input is made:</i>	“quit” is indicated for a moment. Then the display toggles between parameter and the old value setting.	Original setting remains valid and equipment switches back to parameter if input is not confirmed. To change the settings repeat and confirm input.
Turn rotary button until the next parameter is indicated. Or turn the rotary button until the actual value is shown. Or after 30 sec., the actual value is displayed automatically		

Setting the measuring range

Level electrode NRG 2.-.. only : Setting the measuring range, option 1		
Action	Display	Function
Reduce water level until start of measuring range A .		
Select parameter CAL.L.	After a short time, a hexadecimal number flashes.	Calibrate start of measuring range.
Press push-button.	The current hexadecimal number flashes.	
Press button again within 3 sec. (press and hold)	done is displayed. After this, CAL.L and the hexadecimal alternate on the display. After a short time, 0000 % appears.	Input is confirmed. (actual value output = 4 mA)
Fill tank until top end of measuring range B .		
Select parameter CAL.H and press push-button.	After a short time, a hexadecimal number flashes.	Calibrate top end of measuring range.
Press push-button.	The current hexadecimal number flashes.	
Press button again within 3 sec. (press and hold)	done is displayed. After this, CAL.H and the hexadecimal alternate on the display. After a short time, 0100 % appears.	Input is confirmed. (actual value output = 20 mA)

Level electrode NRG 2.-.. only : Setting the measuring range, option 2		
Action	Display	Function
Reduce water level until start of measuring range A .		
Select parameter CAL.L.	After a short time, a hexadecimal number flashes.	Calibrate start of measuring range.
Press push-button.	The current hexadecimal number flashes.	
Press button again within 3 sec. (press and hold)	done is displayed. After this, CAL.L and the hexadecimal alternate on the display. After a short time, 0000 % appears.	Input is confirmed. (actual value output = 4 mA)
Fill tank up to at least 25% of the measuring range.		
Select parameter CAL.H.	After a short time, a hexadecimal number flashes.	Calibrate at a percentage of the measuring range, e.g. 25%.
Press push-button.	The current hexadecimal number flashes.	
Press button again within 3 sec. (press and hold)	done is displayed. After this, CAL.H and the hexadecimal alternate on the display. After a short time, 0100 % appears.	Input is confirmed. (actual value output = 20 mA)
Select parameter CAL.P and set and save a percentage, e.g. 25%.	CAL.P interpolates the value measured at CAL.H to find 100% of the measuring range. CAL.P can be adjusted between 25 and 100%.	



Note

- Adjusting the measuring range: The advantage of option 2 is that the tank only has to be partially filled.

Operation, alarm and test

Setting switchpoints, indicators

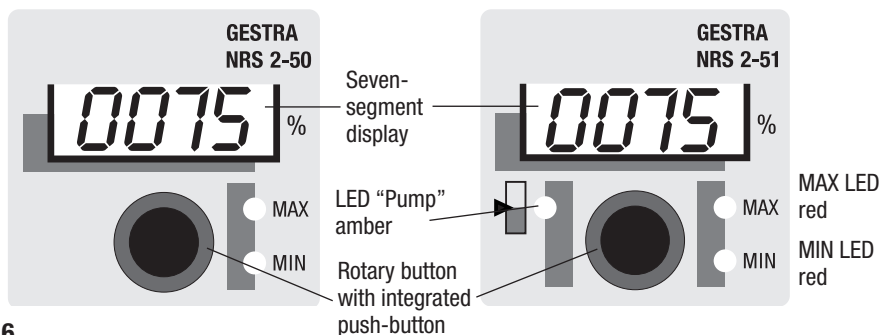

Fig. 6

Setting the MIN/MAX switchpoints	
Select parameter AL.Lo, enter and save the desired percentage.	MIN switchpoint setting between 0-100 %
Select parameter AL.Hi, enter and save the desired percentage.	MAX switchpoint setting between 0-100 %

Level Switch NRS 2-51, only: Setting switchpoints for pump (fill control)	
Select parameter SP.Lo, enter and save the desired percentage.	Switchpoint setting for pump ON between 0-100 %
Select parameter SP.Hi, enter and save the desired percentage.	Switchpoint setting for pump OFF between 0-100 %

Level Switch NRS 2-51, only: Setting switchpoints for pump (discharge control)	
Select parameter SP.Lo, enter and save the desired percentage.	Switchpoint setting for pump OFF between 0-100 %
Select parameter SP.Hi, enter and save the desired percentage.	Switchpoint setting for pump ON between 0-100 %

Operation		
Activity	Display	Function
Water level between MIN and MAX.	MIN and MAX LEDs are not illuminated.	MIN output contact 16/18 open, 17/18 closed. MAX output contact 21/23 open, 22/23 closed.

MIN alarm		
Water level has reached or is below switchpoint MIN.	MIN LED flashes red.	De-energizing delay is running.
	MIN LED illuminated red	Time delay elapsed, MIN output contact 16/18 closed, 17/18 open.

MAX alarm		
Water level has reached or exceeds switchpoint MAX.	MAX LED flashes red.	De-energizing delay is running.
	MAX LED illuminated red	Time delay elapsed, MAX output contact 21/23 closed, 22/23 open.

Operation, Alarm and Test - continued -

Indicators - continued -

Level switch NRS 2-51 only: Fill control		
Level below switchpoint "Pump ON"	Pump LED illuminated amber.	Pump output contact 19/20 closed.
Level above switchpoint "Pump OFF".	Pump LED is not illuminated.	Pump output contact 19/20 open.

Level switch NRS 2-51 only: Discharge control		
Switchpoint "Water level - pump ON" exceeded.	Pump LED illuminated amber.	Pump output contact 19/20 closed.
Level below switchpoint "Water level - pump OFF"	Pump LED is not illuminated.	Pump output contact 19/20 open.

Checking functions of MIN / MAX output contacts

Testing MIN alarm and MAX alarm		
Activity	Display	Function
During operation: Water level between MIN and MAX Select parameter "Test". Press and hold down push-button.	MAX LED flashes red.	De-energizing delay is running.
	MAX LED is illuminated red for 3 sec.	MAX output contact 21/23 closed, 22/23 open.
	MIN and MAX LEDs not illuminated for 1 sec.	MIN output contact 16/18 open, 17/18 open. MAX output contact 21/23 open, 22/23 closed.
	MIN LED flashes red.	De-energizing delay is running.
	MIN LED is illuminated red for 3 sec.	MIN output contact 16/18 closed, 17/18 open.
Test finished, release push-button. Equipment returns to operating mode.	Note: If you continue to hold down the push-button, a new test is started. You can abort the test any moment by releasing the push-button.	
Turn the rotary button until the actual value is shown. If no operation is performed the actual value will be indicated automatically after 30 sec.		



Note

The actual value is shown on the seven-segment display

Troubleshooting

Indication, diagnosis and remedy



Attention

Before carrying out the fault diagnosis please check:

Supply voltage:

Is the equipment supplied with the mains voltage specified on the name plate?

Wiring:

Is the wiring in accordance with the wiring diagram?

Faults indicated by the seven-segment display

Error code	Error	Remedy
E.005	Level electrode defective, measuring voltage < 0.5 VDC	Check level electrode and, if necessary, replace it. Check electrical connection.
	Level transmitter defective, measuring current < 4 mA	Check level transmitter and, if necessary, replace it. Check electrical connection.
E.006	Level electrode defective, measuring voltage > 7 VDC	Check level electrode and, if necessary, replace it. Check electrical connection.
	Level transmitter defective, measuring current > 20 mA	Check level transmitter and, if necessary, replace it. Check electrical connection.
E.012	Beginning and end of measuring range have been switched round.	Re-adjust the measuring range.
E.013	MIN switchpoint above MAX switchpoint	Re-adjust the switchpoints.
In the event of a malfunction a MIN and MAX alarm will be triggered.		



Attention

- Please follow the instructions given in the installation & operating manual for the NRG 21-... , NRG 26-21 and NRGT 26-1.. for further fault finding and troubleshooting.



Note

If a malfunction occurs in the level switch, MIN and MAX alarms will be triggered and the equipment is restarted.

Should this happen over and over again, replace the equipment with a new one.

Further Notes

Action against high frequency interference

High-frequency interference can be caused by out-of-phase switching operations. Should sporadic failures or malfunctions occur take the following remedial actions in order to suppress interference:

- Provide inductive loads with RC combinations according to manufacturer's specification to ensure interference suppression.
- Make sure that all connecting cables leading to the level electrode or to the level transmitter are segregated and run separately from power cables.
- Increase the distance to sources of interference.
- Check the connection of the screen to the central earthing point (CEP) in the control cabinet.
- HF interference suppression by means of hinged-shell ferrite rings.

Decommissioning / replacing the equipment

- Switch off supply voltage and **cut off power supply** to the equipment.
- Remove the lower and upper terminal strips. **Fig. 7**
 - Insert a screwdriver to the right and left of the arrow markings between the terminal strip and the front frame.
 - Unlock terminal strip on the left and right side. For this purpose move screwdriver in direction of the arrow .
 - Remove the terminal strips.
- Release the white fixing slide at the bottom of the equipment and take the equipment off the supporting rail.

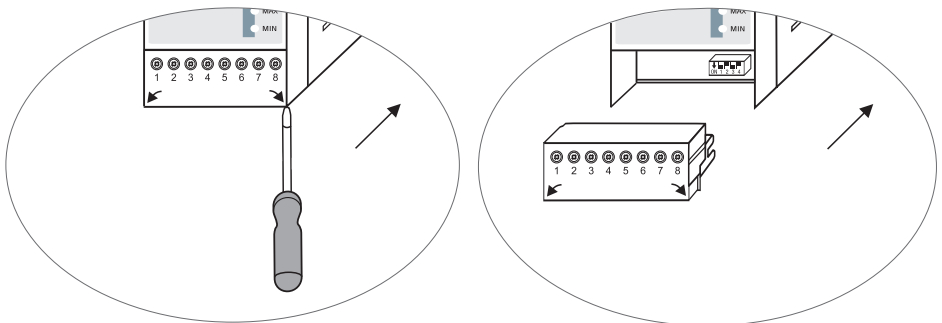

Fig. 7

Disposal

For the disposal of the equipment observe the pertinent legal regulations concerning waste disposal.

If faults occur that are not listed above or cannot be corrected, please contact our service centre or authorized agency in your country.



Agencies all over the world: www.gestra.de

GESTRA AG

Münchener Straße 77

28215 Bremen

Germany

Telefon +49 421 3503-0

Telefax +49 421 3503-393

E-mail info@de.gestra.com

Web www.gestra.de